S P E C F I L E

Product Number : **PT-LB305**

Product Name : LCD Projectors

Specifications

Main unit

Power supply		AC100–240 V 1.5A–3.5A 50 Hz/60 Hz
Power consumption		300 W 6W when Standby mode set to Normal, 0.5W when Standby mode set to Eco
LCD panel	Panel size	16.0 mm (0.63 inches) diagonal (4:3 aspect ratio)
	Display method	Transparent LCD panel (× 3, R/G/B)
	Drive method	Active matrix method
	Pixels	786,432 (1,024 × 768) × 3, total of 2,359,296 pixels
Lens		Manual zoom (1.2×), manual focus F 2.1–2.25, f 19.11–22.94 mm
Throw ratio		1.47–1.77:1
Lamp		230 W UHM lamp
Lamp Replacement Cycle		Normal: 10,000hrs / Eco: 20,000hrs / Quiet: 10,000hrs
Filte*1 Replacement Cycle		Normal: 5,000hrs / Eco: 6,000hrs / Quiet: 10,000hrs
Screen size		0.76–7.62 m (30–300 inches) diagonally, 4:3 aspect ratio
Colors		Full color (16,777,216 colors)
Brightness*2		3,100 lumens (lamp power: normal)
Center-to-corner uniformity*2		85%
Contrast*2		16,000:1 (full on/full off, Iris ON)
Resolution		1,024 × 768 pixels (Input signals that exceed this resolution will be converted to 1,024 × 768 pixels.)
Optical axis shift		6:1 (fixed)
Keystone correction range		Vertical: ±30°
Installation		Ceiling/floor, front/rear (menu selection)
Built-in speaker	Output power	2 W (monaural)
Terminals	HDMI IN	HDMI 19-pin × 1, HDCP and Deep color compatible Audio signal: linear PCM (sampling frequencies: 48 kHz, 44.1 kHz, 32 kHz)
	COMPUTER (RGB) 1 IN	D-sub HD 15-pin (female) × 1
	R, G, B	R, G, B: 0.7 Vp-p, 75 ohms; HD/VD, SYNC: high impedance, TTL (positive/negative automatic)
	Y, P _B (C _B), P _R (C _R)	Y: 1.0 Vp-p (including sync signal), 75 ohms P _B (C _B), P _R (C _R): 0.7 Vp-p, 75 ohms
	S-VIDEO	Y: 1.0 Vp-p; C: 0.286 Vp-p, 75 ohms NOTE: D-Sub -S video conversion cable (ET-ADSV) is required.
	MONITOR OUT	D-sub HD 15-pin (female) × 1
	R, G, B	R, G, B: 0.7 Vp-p, 75 ohms; HD/VD, SYNC: TTL (positive/negative polarity compatible)
	VIDEO IN	Pin jack × 1, 1.0 Vp-p, 75 ohms
	AUDIO IN 1	M3 (L, R) × 1, 0.5 Vrms
	AUDIO IN 2	Pin jack × 2 (L, R × 1), 0.5 Vrms
	AUDIO OUT	M3 (L, R) × 1 (monitor out: 0–2.0 Vrms, variable)
	SERIAL IN	D-sub 9-pin (female) × 1, for external control (RS-232C compliant)

LCD Projectors

Power cord length	1.8 m (5 ft 11 in)
Cabinet materials	Molded plastic
Dimensions (W × H × D)	335 × 96* ³ × 252 mm (13-3/16 × 3-25/32* ³ × 9-29/32 inches)
Weight* ⁴	Approx. 2.8 kg (6.2 lbs)
Operation noise* ²	Normal: 39 dB, Eco: 35 dB, Quiet: 30 dB
Operating temperature	5°C–40°C (41°F–104°F) [at less than 700 m (2,296 ft.); [High land]:[off] 5°C–40°C (41°F–104°F) [at 700 m to 1,400 m (2,296 ft. to 4,593 ft.); [High land]:[on 1] 5°C–35°C (41°F–95°F) [at 1,400 m to 2,700 m (4,593 ft. to 8,858 ft.); [High land]:[on 2]
Operating humidity	20%–80% (no condensation)
Storage temperature	-20°C–60°C
Storage humidity	10%–80%

Remote control unit

Power supply	3 V DC (R03/LR03/AAA type battery × 2)
Operation range* ⁵	Approx. 5 m (16 ft 5 in) when operated from directly in front of the signal receptor
Dimensions (W × H × D)	44 × 105 × 20.5 mm (1-23/32 × 4-1/8 × 13/16 inches)
Weight	Approx. 63 g (2.22 oz) (including batteries)

Supplied accessories

- Power cord (Number and size of cords depends on region)
- Wireless remote control unit (× 1)
- Batteries for remote control (R03/LR03/AAA type × 2)
- Computer signal cable 1.8m [5ft 11in], VGA cable (× 1)

Optional accessories

Ceiling mount bracket	ET-PKL100H (for high ceilings)
Ceiling mount bracket	ET-PKL100S (for low ceilings)
Projector mount bracket	ET-PKL420B
D-SUB - S-Video conversion cable	ET-ADSV
Replacement lamp unit	ET-LAL510
Replacement filter unit	ET-RFL300

Compatible Software

- Multi Monitoring & Control Software (for Windows)
- Presenter Light Software (for Windows)
- Wireless Projector (for iOS and Android)

Power cord

(One set has two cords)
(K2CT3YY00079 x 1) (K2CM3YY00039 x 1)

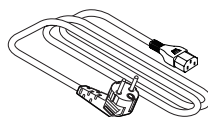
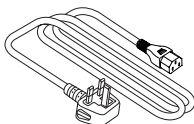

(U Model only x 1)
(K2CG3YY00184)

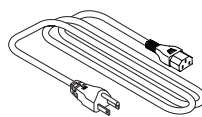

(K Model only x 1)
(K2CM3YY00039)

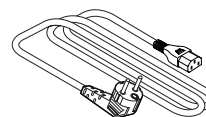

(D Model only x 1)
(K2CZ3YY00061)

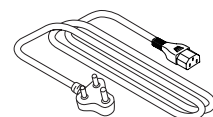

Weights and dimensions shown are approximate. Specifications subject to change without notice.

- *1 Usage environment affects the duration of filter.
- *2 Measurement, measuring conditions, and method of notation all comply with ISO 21118 international standards.
- *3 With legs at shortest position.
- *4 Average value. May differ depending on models.
- *5 Operation range differs depending on environments.

Dimensions

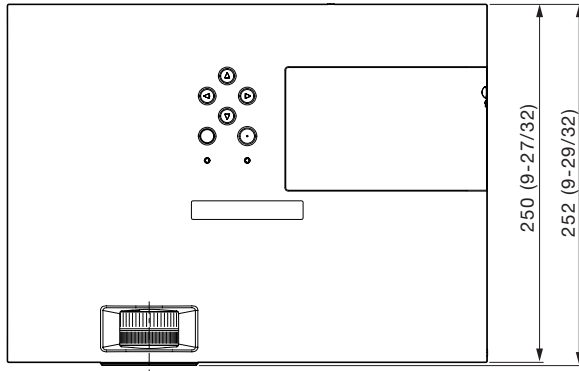

unit : mm (inch)
NOTE: This illustration is not drawn to scale.

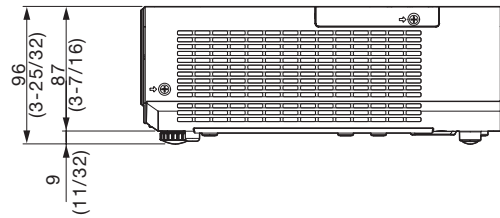
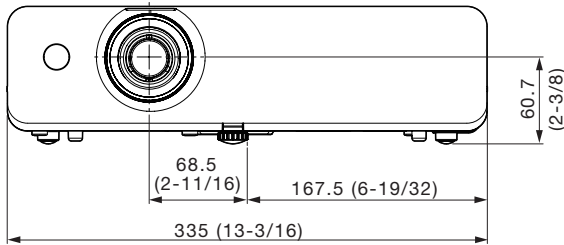

Terminals

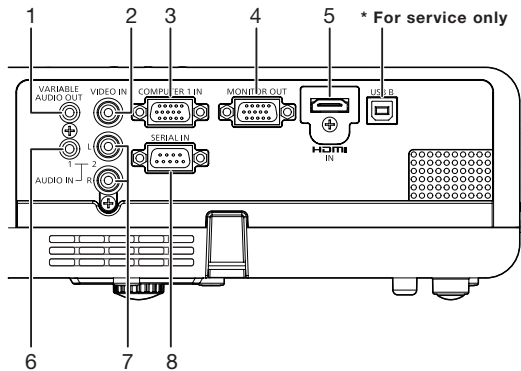

- 1 Audio output
- 2 Video input
- 3 Computer 1 input
- 4 Monitor OUT
- 5 HDMI input
- 6 Audio input 1
- 7 Audio input 2
- 8 Serial input

Standard setting-up position

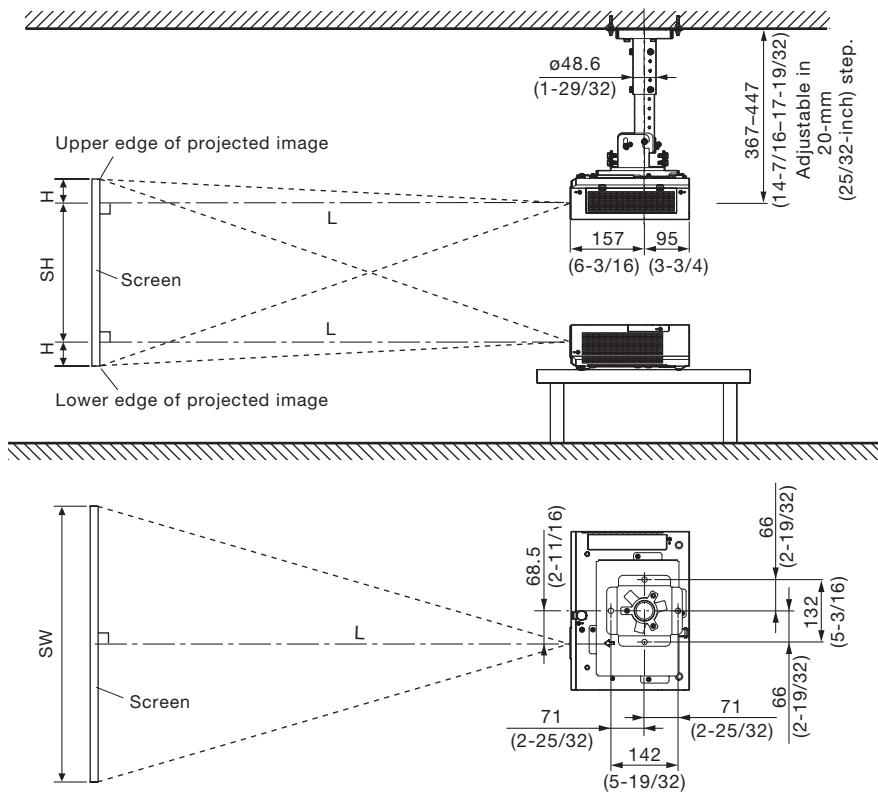

NOTE:
 Illustrations show the projector installed using optional ceiling mount bracket ET-PKL100H and bracket assembly ET-PKL420B.
 This illustration is not drawn to scale.

unit : mm (inch)

Caution:

- All construction work should be done by a qualified technician.
- When mounting to the ceiling, use the special mounting bracket. To prevent the projector from swaying or dropping, attach the wire that is included with Projector Mount Bracket between the Projector Mount Bracket and the ceiling.

Projection distance for 16:9 aspect ratio screen

unit: meters (feet)

Projection size [diagonal]	Projection distance [L]		Height from the edge of screen to center of lens [H]	
	Min [wide]	Max [telephoto]		
0.76 m / 30"	1.0 (3.2)	1.2 (3.8)	0.008	(0.026)
1.02 m / 40"	1.3 (4.3)	1.6 (5.1)	0.011	(0.036)
1.27 m / 50"	1.6 (5.3)	2.0 (6.4)	0.014	(0.046)
1.52 m / 60"	2.0 (6.4)	2.4 (7.7)	0.017	(0.056)
1.78 m / 70"	2.3 (7.5)	2.8 (9.0)	0.019	(0.062)
2.03 m / 80"	2.6 (8.6)	3.1 (10.3)	0.022	(0.072)
2.29 m / 90"	3.0 (9.7)	3.5 (11.6)	0.025	(0.082)
2.54 m / 100"	3.3 (10.8)	3.9 (12.9)	0.028	(0.092)
3.05 m / 120"	3.9 (12.9)	4.7 (15.5)	0.033	(0.108)
3.81 m / 150"	4.9 (16.2)	5.9 (19.4)	0.041	(0.135)
5.08 m / 200"	6.6 (21.6)	7.9 (25.9)	0.054	(0.177)
6.35 m / 250"	8.2 (27.0)	9.9 (32.5)	0.068	(0.223)
7.62 m / 300"	9.9 (32.4)	11.9 (39.0)	0.082	(0.269)

NOTE:

- The value for L (distance to screen) varies slightly depending on the zoom lens characteristics.
- At the shortest projection distance, the zoom lens characteristics may cause slight image distortion.

Projection distance for 4:3 aspect ratio screen

unit: meters (feet)

Projection size [diagonal]	Projection distance [L]		Height from the edge of screen to center of lens [H]
	Min [wide]	Max [telephoto]	
0.76 m / 30"	0.9 (2.9)	1.1 (3.5)	0.065 (0.213)
1.02 m / 40"	1.2 (3.9)	1.4 (4.7)	0.087 (0.285)
1.27 m / 50"	1.5 (4.9)	1.8 (5.9)	0.109 (0.358)
1.52 m / 60"	1.8 (5.9)	2.2 (7.1)	0.131 (0.430)
1.78 m / 70"	2.1 (6.9)	2.5 (8.3)	0.152 (0.499)
2.03 m / 80"	2.4 (7.9)	2.9 (9.5)	0.174 (0.571)
2.29 m / 90"	2.7 (8.9)	3.3 (10.7)	0.196 (0.643)
2.54 m / 100"	3.0 (9.9)	3.6 (11.9)	0.218 (0.715)
3.05 m / 120"	3.6 (11.9)	4.4 (14.3)	0.261 (0.856)
3.81 m / 150"	4.5 (14.9)	5.4 (17.8)	0.327 (1.073)
5.08 m / 200"	6.0 (19.8)	7.3 (23.8)	0.435 (1.427)
6.35 m / 250"	7.6 (24.8)	9.1 (29.8)	0.544 (1.785)
7.62 m / 300"	9.1 (29.8)	10.9 (35.8)	0.653 (2.142)

NOTE:

- The value for L (distance to screen) varies slightly depending on the zoom lens characteristics.
- At the shortest projection distance, the zoom lens characteristics may cause slight image distortion.

Calculation of the projection distance

For a screen size different from the above, use the equation below to calculate the projection distance.

Aspect ratio 16:9

minimum $L (m) = (\text{diagonal screen size in inches}) \times 0.0330 - 0.0233$

maximum $L (m) = (\text{diagonal screen size in inches}) \times 0.0397 - 0.0237$

Aspect ratio 4:3

minimum $L (m) = (\text{diagonal screen size in inches}) \times 0.0303 - 0.0233$

maximum $L (m) = (\text{diagonal screen size in inches}) \times 0.0364 - 0.0237$

NOTE:

Distances calculated with the above equations will include a slight error.

Installable angle

Install the projector at an angle within the range shown below.

• **Vertical direction**

The projector may be installed at a vertical angle of 30°.

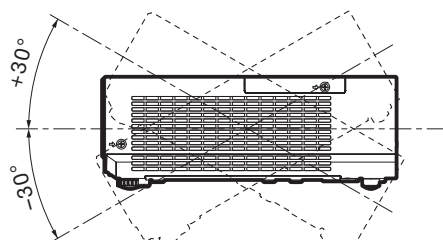

• **Horizontal direction**

The projector may be installed at a horizontal angle of 15°.

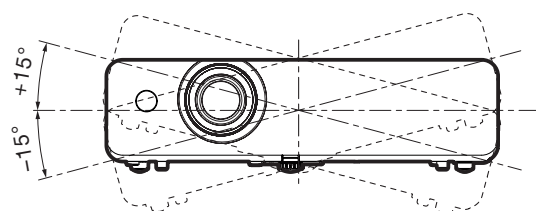

List of compatible signals

The signals that can be input to this projector are shown in the table below. Horizontal scanning frequencies of 15 kHz to 91 kHz, vertical scanning frequencies of 24 Hz to 85 Hz, and a dot clock of 162 MHz maximum can be input.

NOTE: The native resolution of this projector is 1,024 × 768 pixels. If the display resolution of the input signal is different from the native resolution, image compression or expansion will be used to convert the input signal to a level within the native resolution.

Display mode	Display resolution (dots)*1	Scanning frequency		Dot clock frequency (MHz)	Format
		H (kHz)	V (Hz)		
NTSC/NTSC4.43/PAL60/PAL-M	720 × 480i	15.7	59.9	–	S-VIDEO/VIDEO
PAL/PAL-N/SECAM	720 × 576i	15.6	50.0	–	
480i(525i)	720 × 480i	15.7	59.9	13.5	(YCbCr)/RGB
576i(625i)	720 × 576i	15.6	50.0	13.5	
480i(525i)	720(1440) × 480i*2	15.7	59.9	27.0	HDMI
576i(625i)	720(1440) × 576i*2	15.6	50.0	27.0	
480p(525p)	720 × 483	31.5	59.9	27.0	HDMI/
576p(625p)	720 × 576	31.3	50.0	27.0	YPbPr(YCbCr)/RGB
720(750)/60p	1280 × 720	45.0	60.0	74.3	
720(750)/50p		37.5	50.0	74.3	
1080(1125)/60i	1920 × 1080i	33.8	60.0	74.3	
1080(1125)/50i		28.1	50.0	74.3	
1080(1125)/24p	1920 × 1080	27.0	24.0	74.3	
1080(1125)/24sF	1920 × 1080i	27.0	48.0	74.3	
1080(1125)/25p	1920 × 1080	28.1	25.0	74.3	
1080(1125)/30p		33.8	30.0	74.3	
1080(1125)/60p		67.5	60.0	148.5	
1080(1125)/50p		56.3	50.0	148.5	
640 × 480/60	640 × 480	31.5	59.9	25.2	HDMI/RGB
640 × 480/67		35.0	66.7	30.2	
640 × 480/73		37.9	72.8	31.5	
640 × 480/75		37.5	75.0	31.5	
640 × 480/85		43.3	85.0	36.0	
800 × 600/56	800 × 600	35.2	56.3	36.0	
800 × 600/60		37.9	60.3	40.0	
800 × 600/72		48.1	72.2	50.0	
800 × 600/75		46.9	75.0	49.5	
800 × 600/85		53.7	85.1	56.3	
832 × 624/75	832 × 624	49.7	74.6	57.3	
1024 × 768/60	1024 × 768	48.4	60.0	65.0	
1024 × 768/70		56.5	70.1	75.0	
1024 × 768/75		60.0	75.0	78.8	
1024 × 768/85		68.7	85.0	94.5	
1152 × 864/75	1152 × 864	67.5	75.0	108.0	
1152 × 870/75	1152 × 870	68.7	75.1	100.0	
1280 × 720/50	1280 × 720	37.1	49.8	60.5	
1280 × 720/60		44.8	59.9	74.5	

*1 The "i" appearing after the resolution indicates an interlaced signal.

*2 Only compatible with dot clock frequency of 27 MHz (pixel repetition signal)

Display mode	Display resolution (dots)*1	Scanning frequency		Dot clock frequency (MHz)	Format
		H (kHz)	V (Hz)		
1280 × 768/60	1280 × 768	47.8	59.9	79.5	HDMI/RGB
1280 × 768/75		60.3	74.9	102.3	
1280 × 768/85		68.6	84.8	117.5	
1280 × 800/50	1280 × 800	41.3	50.0	68.0	
1280 × 800/60		49.7	59.8	83.5	
1280 × 800/75		62.8	74.9	106.5	
1280 × 800/85		71.6	84.9	122.5	
1280 × 960/60	1280 × 960	60.0	60.0	108.0	
1280 × 1024/60	1280 × 1024	64.0	60.0	108.0	
1280 × 1024/75		80.0	75.0	135.0	
1280 × 1024/85		91.1	85.0	157.5	
1366 × 768/50	1366 × 768	39.6	49.9	69.0	
1366 × 768/60		47.7	59.8	85.5	
1400 × 1050/60	1400 × 1050	65.3	60.0	121.8	
1400 × 1050/75		82.2	74.9	156.0	
1440 × 900/60	1440 × 900	55.9	59.9	106.5	
1600 × 900/60	1600 × 900	55.9	60.0	119.0	
1600 × 900/60	1600 × 900*2	60.0	60.0	118.0	
1600 × 1200/60	1600 × 1200	75.0	60.0	162.0	
1680 × 1050/60	1680 × 1050	65.3	60.0	146.3	
1920 × 1080/60	1920 × 1080*2	66.6	59.9	138.5	
1920 × 1200/60	1920 × 1200*2	74.0	60.0	154.0	

*1 The "i" appearing after the resolution indicates an interlaced signal.

*2 WUXGA resolution is supported only when the signals are compliant with VESA CVT-RB (Coordinated Video Timing-Reduced Blanking).

Weights and dimensions shown are approximate. Specifications and appearance are subject to change without notice. Product availability differs depending on region and country. This product may be subject to export control regulations.

The terms HDMI and HDMI High-Definition Multimedia Interface, and the HDMI Logo are trademarks or registered trademarks of HDMI Licensing Administrator, Inc. in the United States and other countries.

Trademark PJLink is a trademark applied for trademark rights in Japan, the United States of America and other countries and areas. All other trademarks are the property of their respective trademark owners.