

Panasonic

AW-HE130W/K

HD Integrated PTZ Camera



AW-HE130W

AW-HE130K

For indoor use



Production Quality HD Video
via 3G-SDI and IP Streaming



Advanced Video Processing for High Quality Video Image.

Three newly developed 1/2.86-type MOS sensors for high-level video capture and production.

Equipped with three newly developed 1/2.86-type full HD MOS sensors and DSP (Digital Signal Processor), AW-HE130W/K achieves high sensitivity, a high S/N ratio and high resolution through the use of advanced video processing.

Optical Image Stabilizer and Digital Extender for capturing clear images at any distance.

Optical Image Stabilization System (OIS)

Automatically minimizes the effect of small vibrations from the surface where the camera is mounted caused ; whether this is caused by the opening and closing of doors, nearby speakers, or other disturbances.

High Performance 20x Zoom Lens/1.4x Digital Extender Zoom

In addition to a sharp, fast F1.6, 20x optical zoom lens, the AW-HE130W/K is equipped with an innovative 1.4x digital extender that can increase the effective focal length of the lens by 40% while delivering smooth, high resolution video.



*Images are simulated

Advanced color adjustment capabilities for precision imaging

Independent Color Correction Function with 12 Color Axes + 3 Skin Tone Axes

In addition to the conventional 12 axes, three additional axes have been added for the skin tone area. This makes it possible to reproduce skin tones with greater precision.

Conventional model

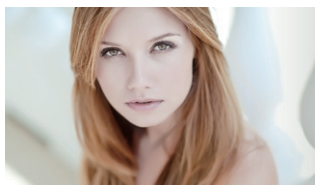

AW-HE130W/K

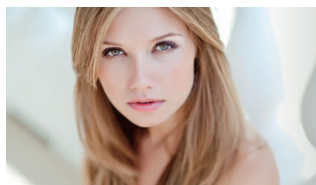

*Images are simulated

Color Temperature Adjustment Mode

In addition to the usual white balance modes, a new variable Color Temperature-based function has been added. This makes it easier to make the precise camera adjustments required for different lighting conditions.



*Images are simulated

Dynamic Range Stretch (DRS) / Hybrid Digital Noise Reduction (Hybrid DNR)

Black defects, halation and washed-out colors are minimized for video images with a visually broad dynamic range (DRS). In addition, with Hybrid Digital Noise Reduction (Hybrid DNR), two types of noise reduction, 2D and 3D, are used together to enable clear video capture under a wide range of lighting conditions, with minimal after-image blurring or image degradation.

Equipped with Night Mode for infrared shooting

The AW-HE130W/K can deliver high-quality monochrome video in total darkness, when the camera's Night Mode is used in conjunction with an optional IR illuminator.



*Images are simulated

Freeze During Preset function

The new Freeze During Preset function may be enabled to freeze the video during preset playback. The immediately preceding still image is output during preset movements so that the swiveling movement is not displayed, making operations possible with one camera.

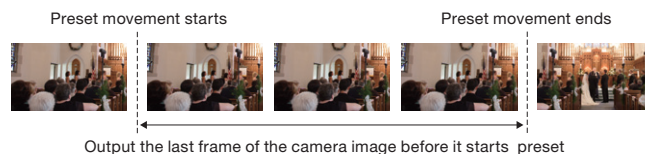

Supports multiple formats for flexible output

In addition to typically supported formats, the camera supports output formats required for specialized applications, including 1080/29.97p, 1080/25p, 1080/23.98p. Remote control video capture can now be more easily performed for specialized applications such as teleproduction, and scientific research.

Supported formats

1080/59.94p, 1080/29.97p^{*1}, 1080/23.98p^{*2*3}, 1080/59.94i, 1080/29.97PsF^{*3}, 1080/23.98PsF^{*3}, 1080/50p, 1080/25p^{*1}, 1080/50i, 1080/25PsF^{*4}, 720/59.94p, 720/50p, 576/50p (i)^{*5}, 480/59.94p (i)^{*5},

Audio input function

The AW-HE130W/K also supports audio input, embedding, and encoding. The input from the camera's switchable mic/line input can be combined with the HD-SDI, HDMI, and streaming outputs for mixing, recording or transmission.

Excellent quietness

Thanks to its fan-less design and advanced pan-tilt mechanism, the AW-HE130W/K is very quiet and greatly reducing audio noise during video capture.

*1: Native output. *2: OVER 59.94i. *3: Your monitor may recognize the signal as 59.94i. *4: Your monitor may recognize the signal as 50i. *5: A 'P' signal is output as HDMI output, an 'I' signal is output as SDI and an analog output for output formats of 480/59.94p(i) and 576/50p(i).

A Single Cable Solution for Remote Video and Audio Capture

Full HD video output via IP transmission

In addition to 3G-SDI and HDMI output, production quality full HD video output via IP transmission is supported with the AW-HE130W/K. The camera delivers up to four channels of IP streaming video (H.264), with a maximum quality level of 1080/60p at 24 Mbps*1. Simultaneous transmission to as many as 14 devices is also supported.*2 Flexible system setup is possible to meet various application needs.



List of Supported Multi-streaming Outputs

| Settings | H.264 | | | JPEG |
|--------------------|------------------------|---|---|--|
| | CH1 | CH2 | CH3/CH4 | CH1/CH2/CH3 |
| Resolution | 1920x1080/ 1280x720 | 1920x1080/ 1280x720/640x360/ 320x180/160x90 | 1280x720/ 640x360/320x180/ 160x90 | 1920x1080/ 1280x720/640x360/ 320x180/160x90 |
| Frame rate | 60 Hz | 60 fps | 5 fps/15 fps/30 fps | 1 fps/2 fps/3 fps/ 5 fps/6 fps/10 fps/ 15 fps/30 fps |
| | 50 Hz | 50 fps | 5 fps/12.5 fps/25 fps | 1 fps/2 fps/5 fps/10 fps/ 12.5 fps/25 fps |
| Bit rate | Up to 24 Mbps | | | |
| Voice transmission | Yes (AAC48 kHz) | | | |
| PoE+ | Yes | | | |

NDI|HX Compatibility for Excellent Video Streaming Quality

The AW-HE130W/K can be upgraded to an NDI|HX compatible model if purchasing a license from the NewTek website (https://pro-av.panasonic.net/en/ndihx_support/index.html). Highly efficient NDI|HX compatibility enables excellent broadcast streaming by encoding and transmitting high-quality video in real time. This technology eliminates the need for IP decoders, allowing input to be sent directly to the switcher.

* Contact your local Panasonic vendor for further information.

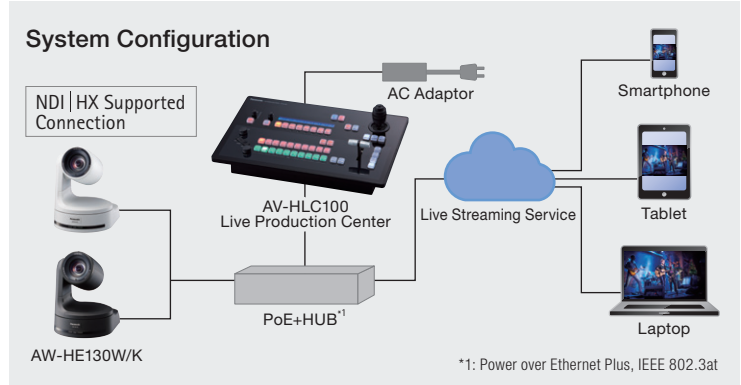

Supporting POE+*3 for lower installation cost

By connecting to network devices that support the IEEE 802.3at POE+ standard, power can be supplied via LAN cable. Since it is not necessary to install a power supply or even a local A.C. outlet, installation costs can be significantly reduced.

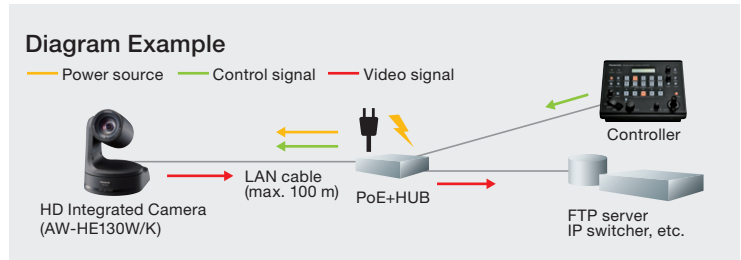

IP control with image monitoring using PC, Mac and mobile terminals

Using an IP browser, such as Internet Explorer or Safari, it is possible to set up and control the camera from a remote location. This feature simplifies the management of cameras around a campus, or across a worldwide enterprise network. IP video monitoring and remote camera control can also be performed from mobile terminals such as an iPhone, iPad or Android device.

* For the latest information on supported OS/browser, please refer to the "service and support" on the Panasonic website (<https://pro-av.panasonic.net>).



Flexible IP Control Architecture Simplifies System Design and Operation*4

Up to 100 x AW-HE130W/K cameras can be controlled via IP from a single AW-RP120G, AW-RP50, or PC. An AW-HE130W/K can also be simultaneously controlled by up to five AW-RP120G or AW-RP50's via IP. AK-HRP200G can be used for precise color adjustment.

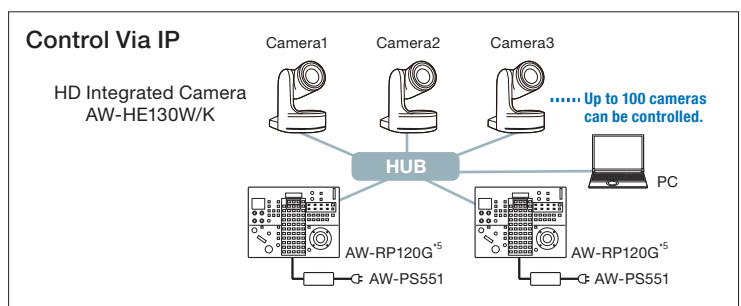

*1: 1920 x 1080 60 fps output is 1ch display only. For 2ch or more, display is max. 30 fps. Also, JPEG output is up to 3ch.

*2: The number varies depending on distribution settings or network environment. Only one Android™ device can be connected to one camera.

*3: Abbreviation of Power over Ethernet Plus.

*4: Controller upgrade required. For details, please refer to the "service and support" on the Panasonic website (<https://pro-av.panasonic.net>).

*5: AC adaptor AW-PS551 (sold separately) is required for AW-RP120G.

Exceptional Pan-Tilt mechanism performance for smooth moves during video capture.

Thanks to a highly evolved pan-tilt design, the AW-HE130W/K achieves smoother and more natural movement during on-air shots. The pan-tilt head also has a wide shooting range*, with a pan range of $\pm 175^\circ$ and a tilt range of -30° to 210° . The newly developed pan-tilt drive provides high-speed operation at maximum $60^\circ/s$, excellent response to remote control operation, and highly precise stop control. These features combine to accurately capture fast-action sports scenes or smooth concert footage. The noise level during operation is also very low, at NC35 or less, which is ideal for use in quiet environments.

* Depending on the position of the pan and tilt, its own unit may be reflected in the image.

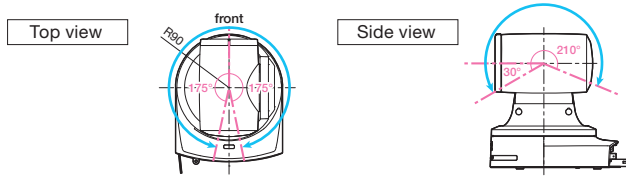

Other Functions

- Equipped with ND filters (Through, 1/8, 1/64).
- Equipped with four types of scene files that can be set by the user.
- Preset memory of up to 100 positions.
- Functions such as freeze during preset, digital extender zoom, color temperature settings can be assigned to the user buttons on Panasonic controllers.
- Equipped with RS422 remote terminal; up to five units can be controlled via serial control from a controller.
- Equipped with RS232C remote terminal (Standard serial communication support).
- Up to four units can be operated with a wireless remote controller (AW-RM50G sold separately).
- Easy installation thanks to use of turn-lock mechanism.
- Color variations (black/white) that can be chosen for different applications or conditions.

System configuration example

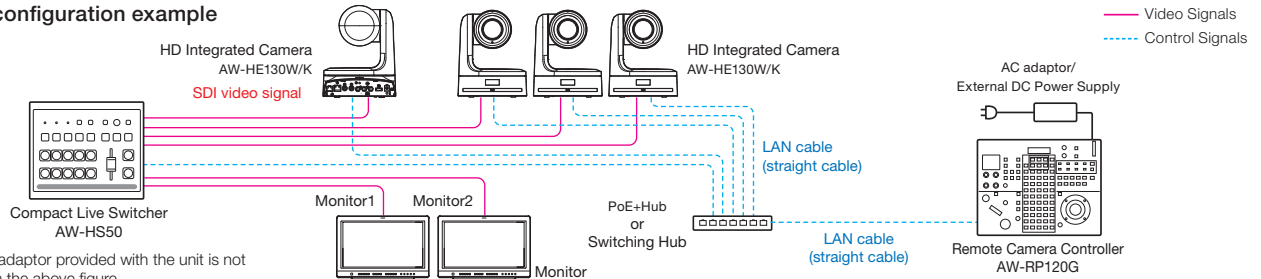

Optional Software

Supporting Lecture Capture with Auto Tracking function

Auto Tracking Software Key
AW-SF100/AW-SF200
2 Additional Licenses AW-SF202
3 Additional Licenses AW-SF203

A 30-day Free Trial is Available



AW-SF200 Main View

(Main Features)

- Motion detection and face detection technologies using video streaming from camera achieve smooth auto tracking regardless of where the person is facing.
- GUI designed for intuitive operation.
- Operation with IP connection enables installation/control of cameras in remote classroom.
- AW-SF100 allows a single PTZ camera to be controlled on either a stand-alone or web application version.
- The stand-alone version is easy to set up by installing software on a PC*1 and connecting HD integrated cameras; Installation of sensors and other devices are not necessary.
- The web application version enables camera control from a tablet, smartphone, desktop PC, etc.
- AW-SF200 enables simultaneous auto tracking and centralized control of multiple cameras.*2

*1: When the web application version is used, Auto Tracking Software needs to be installed on an HTTP server.

*2: Up to four cameras per server can be controlled simultaneously.

● The face recognition function is based upon the face recognition software developed by PUX Corporation. * Depending on the shooting environment, the system may not be able to detect or track the target correctly. Please use this software in an environment where the adjustment work can be performed by the operator to deal with errors in detection and auto tracking. * There is a 30-day free trial available for the Auto Tracking Software. Please read carefully the precautions for this software and check if it works correctly in your operating environment before you purchase "Auto Tracking Software Activation Key". For further information, please see "Software Download" on the Panasonic website <<https://pro-av.panasonic.net/>>.

PTZ Control Center

Free Software

- Intuitive GUI with the capability to control multiple cameras.
- Image quality adjustment and pan-tilt-zoom control on a GUI.
- Easy to recall presets by clicking preset buttons with thumbnails.



Main View

PTZ Virtual USB Driver

Free Software

- High quality video perfect for web conferencing, utilizing a PTZ camera on the network as a USB camera.
- Automatic detection of connected cameras, and network settings supported.

* For further information on the optional software, please see "Software Download" on the Panasonic website <<https://pro-av.panasonic.net/>>.

Easy Wireless Control Using an iPad*3 with a Control Assist Camera*4



Control Assist Camera
AW-HEA10W

- Range of lens movement
This is adjustable 30° vertically and 45° horizontally.

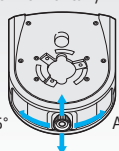

Approx. 45° Approx. 45°
Approx. 30°

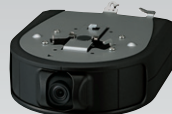

Control Assist Camera
AW-HEA10K

- Usage example

4K/HD Integrated Camera video
Control Assist Camera video



- Used in combination with a 4K/HD Integrated Camera*4.
- 95° wide-angle view from the Control Assist Camera is displayed on an iPad.
- Tapping the desired area of the wide-angle view displayed on the iPad*3 turns the field of view of the 4K/HD Integrated Camera*4 to the tapped position.

*3: An iPad (sold separately) and a wireless AP (sold separately) are required. Please install the iPad application "PTZ Cntrl" (free). For details, please visit Panasonic AW-HEA10W/K website (https://pro-av.panasonic.net/en/sales_o/camera/aw-hea10/).

*4: AW-HE130/HN130 series, AW-UE70/UN70 series, AW-HE40/HN40 series, and AW-HE38/HN38 series only.

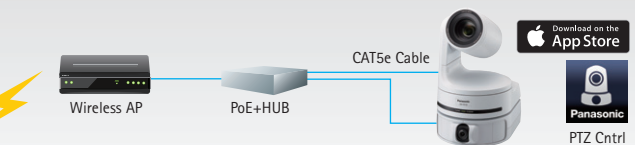

The iPad application "PTZ Cntrl" can be downloaded for free from the App Store. This application enables control of pan, tilt, zoom, focus, iris and gain. For details, please visit the Panasonic AW-HEA10W/K product site (https://pro-av.panasonic.net/en/sales_o/camera/aw-hea10/).

Specifications

As of April, 2018

| | | | | | | | |
|---------------------------|---------------------------------|--|---------------------------|--|--|---|---|
| GENERAL | Power requirements | DC 12 V (AC adaptor supplied) DC 42 - 57 V (PoE+ power supply) | FUNCTIONS AND PERFORMANCE | Gain selection | Auto, 0 dB to 36 dB | | |
| | Current consumption | 1.8 A (AC adaptor supplied) 0.6 A (PoE+ power supply) | | Frame mix*2 | 0 dB, 6 dB, 12 dB, 18 dB, 24 dB | | |
| | Ambient operating temperature | 0 °C to 40 °C (32 °F to 104 °F) | | Electronic shutter speed | 59.94p/59.94i: | 1/100, 1/120, 1/250, 1/500, 1/1000, 1/2000, 1/4000, 1/10000 | |
| | Storage temperature | -20 °C to 50 °C (-4 °F to 122 °F) | | | 29.97p: | 1/30, 1/60, 1/120, 1/250, 1/500, 1/1000, 1/2000, 1/4000, 1/10000 | |
| | Allowable humidity ranges | 20 % to 90 % (no condensation) | | | 23.98p: | 1/24, 1/60, 1/120, 1/250, 1/500, 1/1000, 1/2000, 1/4000, 1/10000 | |
| | Mass | Approx. 3.1 kg (6.83 lb) [Including mount bracket] | | | 50p/50i: | 1/60, 1/120, 1/250, 1/500, 1/1000, 1/2000, 1/4000, 1/10000 | |
| | Dimensions (W x H x D) | 180 mm x 228 mm x 234 mm (7-3/32 inches x 9 inches x 9-3/16 inches) (excluding protrusions, cable cover, direct ceiling mount bracket) | | Controller supported*1 | 25p: | 1/25, 1/60, 1/120, 1/250, 1/500, 1/1000, 1/2000, 1/4000, 1/10000 | |
| | Finish | AW-HE130WP/AW-HE130WE: Pearl white AW-HE130KP/AW-HE130KE: Metallic black | | | Synchro scan | 59.94 Hz: 60.15 Hz to 642.21 Hz 50 Hz: 50.15 Hz to 535.71 Hz | |
| INPUT | Input connector | DC 12 V IN, G/L IN (BNC) | FUNCTIONS AND PERFORMANCE | Gamma | HD, SD, FILMLIKE1, FILMLIKE2, FILMLIKE3 0.30 to 0.75 (Manual setting) | | |
| | | • BBS (Black Burst Sync), tri-level sync supported • Locking to a color subcarrier is not possible with BBS. PoE+ (IEEE802.3at standard) | | White balance | AWB A, AWB B, ATW, 3200K, 5600K, VAR (2000K to 15000K) | | |
| OUTPUT | Video output | HDMI | | • HDCP is not supported. • Viera Link is not supported. | Chroma amount variability | OFF, -99 % to 40 % | |
| | | 3G/HD/SD-SDI OUT | | SMPTE424/SMPTE292/SMPTE259 standards 75 Ω (BNC×1) | Scene file | Scene1, Scene2, Scene3, Scene4 | |
| INPUT/ OUTPUT | Input/ Output connector | VIDEO OUT | | NTSC/PAL 1.0 V [p-p]/75 Ω (BNC×1) | Output format | 1080/59.94p, 1080/29.97p*3, 1080/23.98p*4*5, 1080/59.94i, 1080/29.97PsF*5, 1080/23.98PsF*5, 1080/50p, 1080/25p*3, 1080/50i, 1080/25PsF*6, 720/59.94p, 720/50p, 576/50p (i)*7, 480/59.94p (i)*7, | |
| | | LAN | | LAN connector for IP control (RJ-45) | | Synchronization system | Internal/External synchronization (BBS/Tri-level sync) |
| | | RS-422 | | CONTROL IN RS-422A (RJ-45) | [Pan-tilt head unit] | Installation method | Stand-alone (Desktop) or suspended (Hanging)*8 |
| | | φ3.5 mm stereo mini jack | | Input impedance: High impedance • During MIC input Supported mic: Stereo mic (plug-in power, on/off switching via menu) • Supply voltage: 2.5 V ± 0.5 V Mic input sensitivity: Approx. -40 dBV ± 3 dBV (0 dB=1 V/Pa, 1 kHz) • During LINE input Input level: Approx. -10 dBV ± 3 dBV | Camera/pan-tilt head control | | IP connecting cable • When connecting through a hub: LAN cable*9 (category 5e or above, straight cable), max. 100 m (328 ft) • When a hub is not used LAN cable*9 (category 5 or above, crossover cable) max.100 m (328 ft) RP connecting Cable LAN cable*9 (category 5 or above, straight cable), max. 1000 m (3280 ft) RS-422A, AW series protocol |
| FUNCTIONS AND PERFORMANCE | [Camera unit] | FUNCTIONS AND PERFORMANCE | FUNCTIONS AND PERFORMANCE | Pan-tilt operation speed | 0.08°/s to 60°/s | | |
| | Imaging sensors | | | 1/2.86-type Full-HD 3MOS | Panning range | ±175° | |
| | Lens | | | Motorized 20 zoom, F1.6 to F3.4 (f=4.5 mm to 90 mm; 35 mm equivalent: 32.13 mm to 642.5 mm) | Tilting range*10 | -30° to 210° | |
| | Focus | | | Switching between auto and manual | Quietness | NC35 or less | |
| | Focus distance | | | Entire zooming range: 800 mm (2.62 ft) Wide end: 400 mm (1.31 ft) | | | |
| | Color separation optical system | | | 3MOS | | | |
| | Minimum illumination | | | 2 lx (50 %, F1.6, 36 dB) | | | |
| | Horizontal resolution | | | 1000 TV lines Typ (Center area) | | | |

*1: It may be necessary to upgrade the version of the controller in order to support the unit. For details on upgrading, visit the support page on the following website. <https://pro-av.panasonic.net/> *2: This cannot be configured when the format is 1080/29.97p, 1080/23.98p, 1080/29.97PsF, 1080/23.98PsF, 1080/25p, or 1080/25PsF. *3: Native output. *4: OVER 59.94i. *5: Your monitor may recognize the signal as 59.94i. *6: Your monitor may recognize the signal as 50i. *7: A 'P' signal is output as HDMI output, an 'I' signal is output as SDI and an analog output for output formats of 480/59.94p(i) and 576/50p(i). *8: To ensure safety, the unit must be secured using the mount bracket supplied. *9: Use of an STP (shielded twisted pair) cable is recommended. *10: Depending on the pan or tilt position, the camera may be reflected in the image.

Computer requirements

As of April, 2018

| | |
|--|--|
| CPU | Intel® Core™ 2 DUO 2.4 GHz or more |
| Memory | For Windows: 1 GB or more (2 GB or more for 64-bit editions of Microsoft® Windows® 8.1, Microsoft® Windows® 8, and Microsoft® Windows® 7) |
| | For Mac: 2 GB or more |
| Network function | 10BASE-T or 100BASE-TX port × 1 |
| Image display | Resolution: 1024 × 768 pixels or more |
| | Color generation: True Color 24-bit or more |
| Supported operating systems and web browsers | For Windows: Microsoft® Windows® 8.1 Pro 64-bit / 32-bit *1 Windows® Internet Explorer® 11.0*1 *3 Microsoft® Windows® 8 Pro 64-bit / 32-bit *1 Windows® Internet Explorer® 10.0*1 *3 Microsoft® Windows® 7 Professional SP1 64-bit / 32-bit *2 Windows® Internet Explorer® 11.0 / 10.0 / 9.0 / 8.0 *3 |
| | For Mac: OS X 10.9 Safari 7.0.2 OS X 10.8 Safari 6.1.2 OS X 10.7 Safari 6.1.2 |
| | For iPhone, iPad, iPod touch: iOS 7.1 Standard web browsers |
| | For Android: Android OS Standard web browsers |
| Other | CD-ROM drive (for using the Operating Instructions and various software) Adobe® Reader® (for viewing the Operating Instructions on the CD-ROM) |

*1 Use the desktop version of Internet Explorer. (Internet Explorer for Windows UI is not supported.)
*2 Windows® XP compatibility mode is not supported.
*3 The 64-bit version of Internet Explorer® is not supported.
*4 For the latest information on supported OS/browser, please refer to the "service and support" on the Panasonic website (<https://pro-av.panasonic.net/>).



Rear view



Standard Accessories

- Mount bracket for installation surface (Hanging / Desktop)
- Drop-prevention wire
- Drop-prevention wire mounting screw (comes attached to the unit)
- Bracket mounting screws (bind-head) M4 x 10 mm
- Main unit mounting screw (with flat washer, spring washer) M3 x 6 mm
- Cable cover
- Power cable
- CD-ROM
- AC adaptor

Bottom view

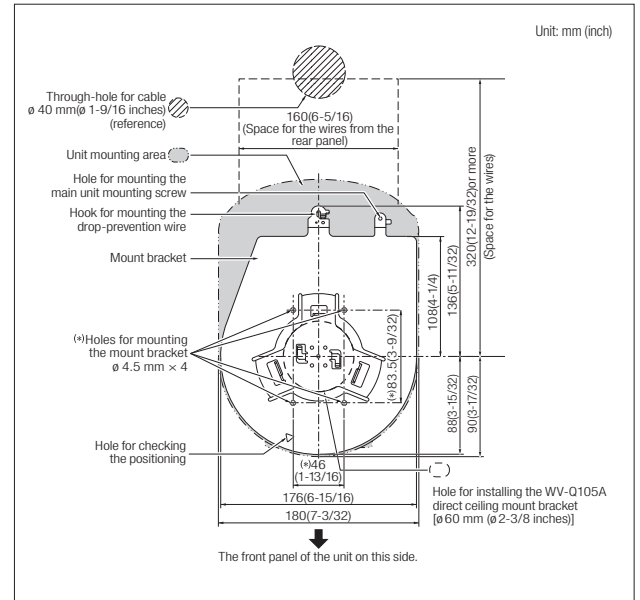

System Camera Options

As of April, 2018

| | | |
|--|--|---|
| <p>Live Production Center AV-HLC100</p> | <p>Control Assist Camera AW-HEA10W</p> | <p>Control Assist Camera AW-HEA10K</p> |
| <p>Remote Operation Panel AK-HRP200G (AC adaptor (DC12 V) is required separately.)</p> | <p>Remote Camera Controller AW-RP50</p> | <p>Remote Camera Controller AW-RP120G (AC adaptor (DC12 V) is required separately.)</p> |
| <p>Wireless Remote Control AW-RM50G (*AA, *R6* or *LR6* battery x 2 are not included.)</p> | <p>Direct Ceiling Mount Bracket WV-Q105A</p> | |

For more information, please visit Panasonic web site



<https://pro-av.panasonic.net/>

*Specifications are subject to change without notice.

Panasonic®

Panasonic Corporation
Connected Solutions Company

2-15 Matsuba-cho, Kadoma, Osaka 571-8503 Japan
<https://pro-av.panasonic.net/>

[Countries and Regions]

Argentina +54 11 4122 7200
Australia +61 (0) 2 9491 7400
Brazil +55 11 3889 4035
Canada +1 905 624 5010
China +86 10 6515 8828
Hong Kong +852 2313 0888
Czech Republic +421 (0) 903 447 757
Denmark +45 43 20 08 57
Egypt +20 2 23938151
Finland, Latvia, Lithuania, Estonia +358 (9) 521 52 53
France +33 (0) 1 47 91 64 00
Germany, Austria, Switzerland +49 (0) 6103 313887
Greece +30 210 96 92 300
Hungary +36 (1) 382 60 60
India +91 1860 425 1860
Indonesia +65 6277 7284
Iran (Vida) +98 21 2271463
(Panasonic Office) +98 2188791102
Italy +39 02 6788 367
Jordan +962 6 5859801
Kazakhstan +7 727 330 8808
Korea +82 2 2106 6641

Kuwait +96 522431385
Lebanon +96 11665557
Malaysia +60 3 7809 7888
Mexico +52 55 5488 1000
Mongolia +976 70115577
Netherlands, Belgium +31 73 640 2729
New Zealand +64 9 272 0100
Norway +47 67 91 78 00
Pakistan +92 21 111 567 111
Palestine +972 2 2988750
Panama +507 229 2955
Philippines +65 6277 7284
Poland +48 (22) 338 1100
Portugal +351 21 425 77 04
Romania, Albania, Bulgaria, Macedonia +40 (0) 729 164 387
Russia & CIS +7 495 9804206
Saudi Arabia +966 (1) 4790499
Singapore +65 6277 7284
Slovak Republic, Croatia, Serbia, Bosnia, Montenegro, Slovenia +421 (0) 903 447 757
South Africa +27 11 3131622
Spain +34 (93) 425 93 00

Sweden +46 (8) 680 26 41
Taiwan +886 2 2227 6214
Thailand +662 731 8888
Turkey +90 216 578 3700
U.A.E. (for All Middle East) +971 4 8862142
Ukraine +380 44 4903437
U.K. +44(0)1344 70 69 13
U.S.A. +1 877 803 8492
Vietnam +65 6277 7284



Factories of AVC Networks Company have received ISO14001:2004-the Environmental Management System certification. (Except for 3rd party's peripherals.)